

Barangaroo T1&T2&T3 Towers

Scope:Supply
bespoken stainless steel
stanchions,patch
fittings,spider brackets

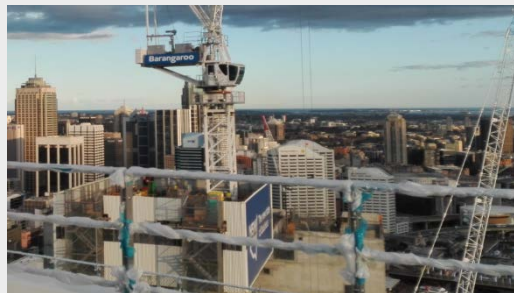

Crown Casino Sydney

Scope:Supply

bespoke stainless steel
panel to Podium

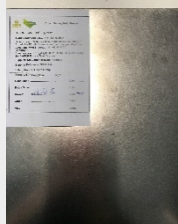

Macquarie-Park-Building-

C

Scope: Supply
bespoke stainless steel patch
fittings&brackets

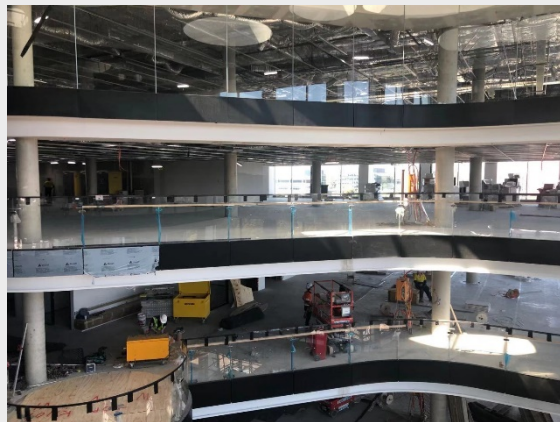

Kingsleys Hotel Sydney

Scope: Bespoken 9000mm long
Stainless Steel Mirror Finish T-plate



Forrest Chase Shopping Center WA

Scope: Supply bespoke stainless steel stanchions, patch fittings, spider brackets



EZONE UWA AUSTRALIA

Scope: Supply
bespoke stainless steel patch
fittings&outrigger



Canberra International Airport

Scope: Supply
Routel&Spider fittings

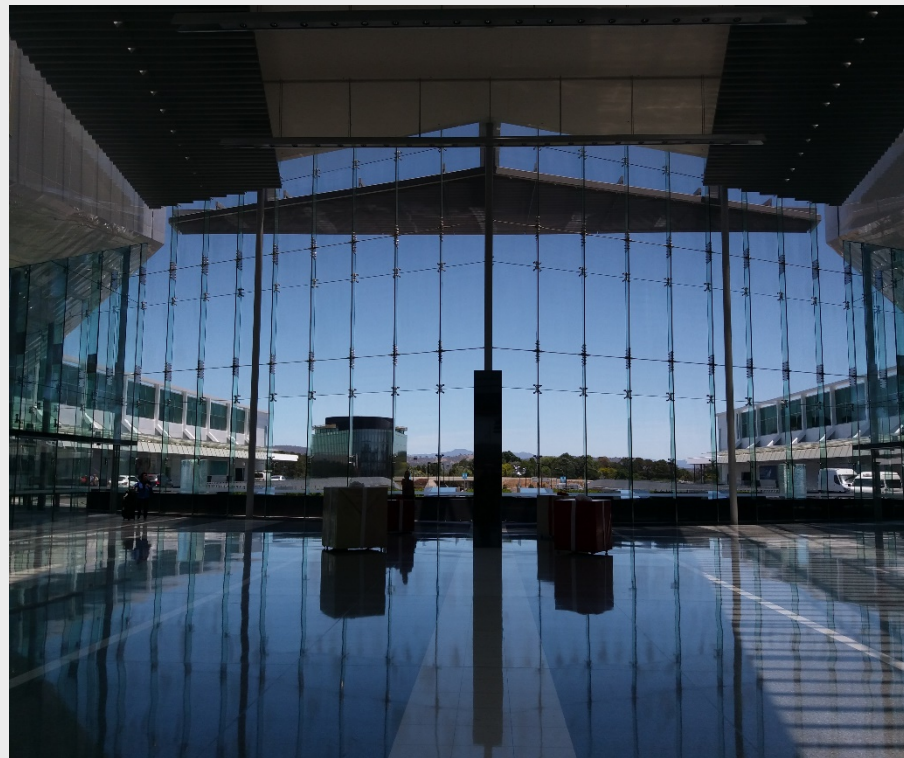
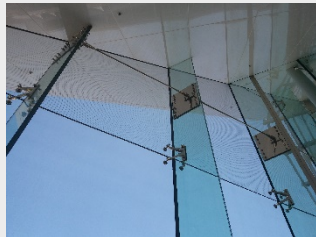
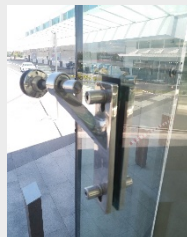

Bunjil Place

Scope: Bespoke clamp

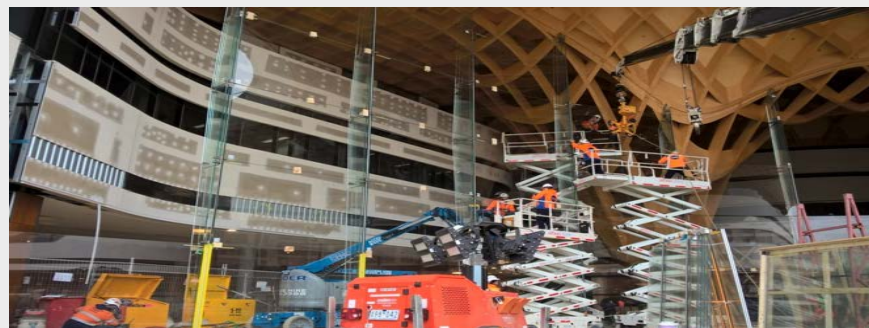
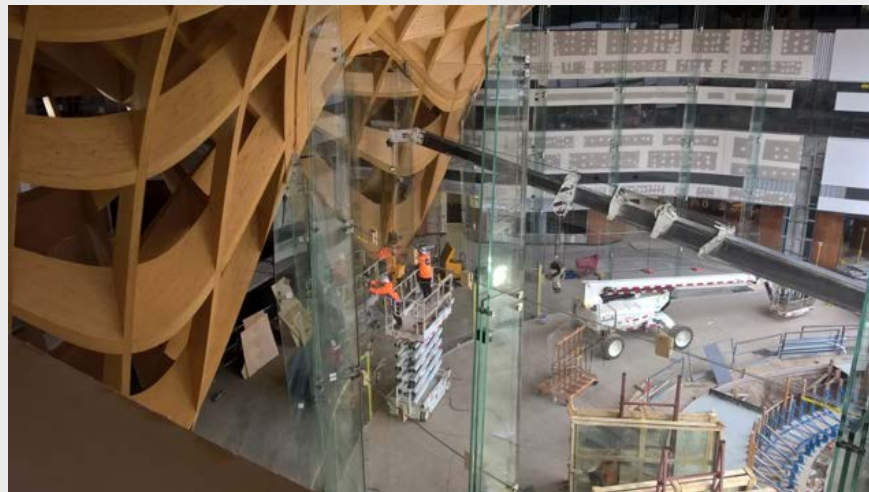

Brisbane One, QLD
Scope: Multi-Point
Window&Door Locking Systems



164 Substation Sydney

Scope: Bespoke

Stainless Steel Packages

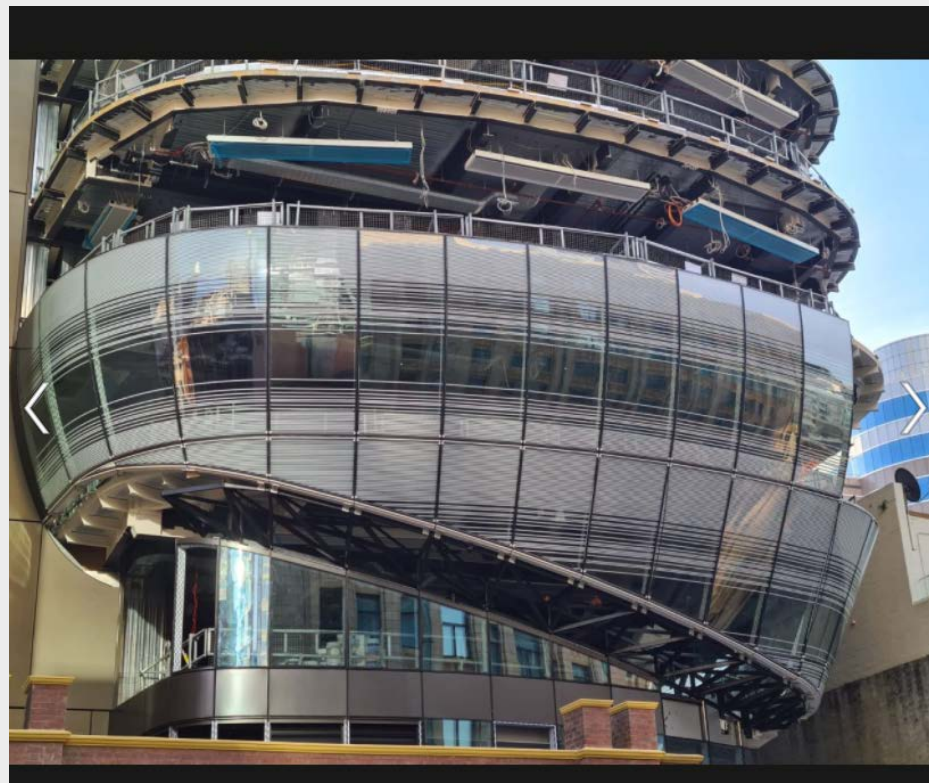

250 Spencer St, Melbourne

Scope: Bespoke

Stainless Steel Cladding

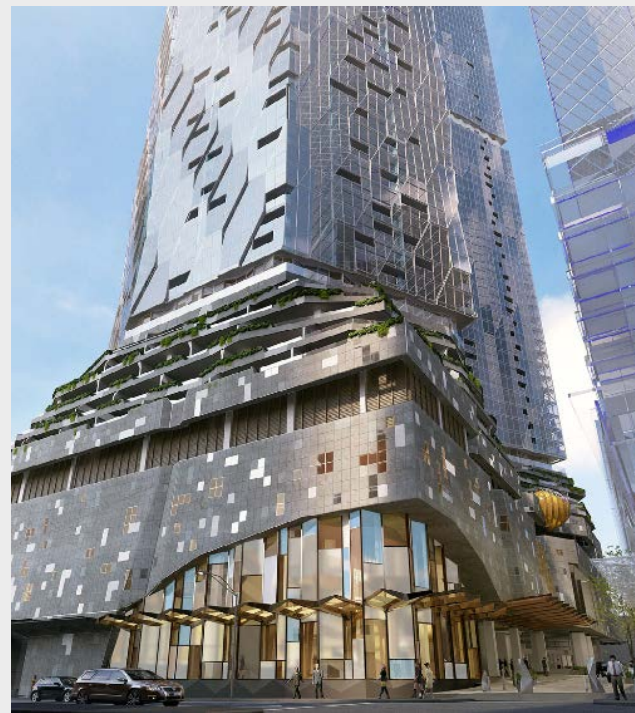
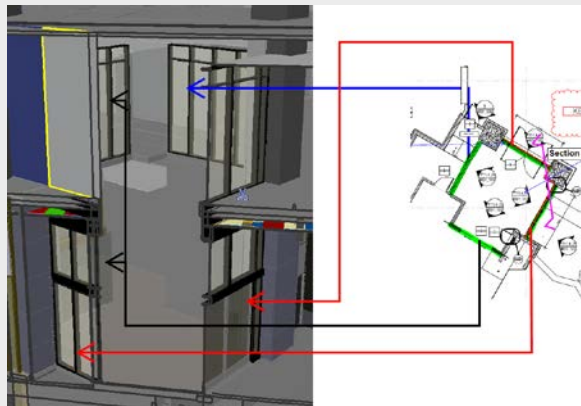
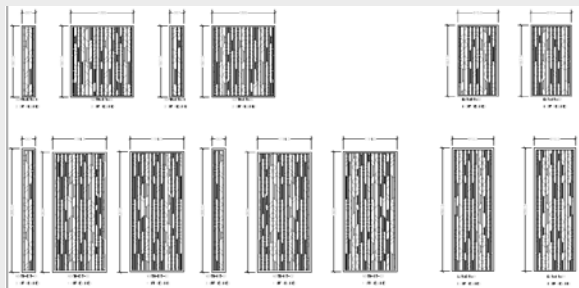

Central Sydney Station Redevelopment Scope: Bespoke Stainless Steel Packages

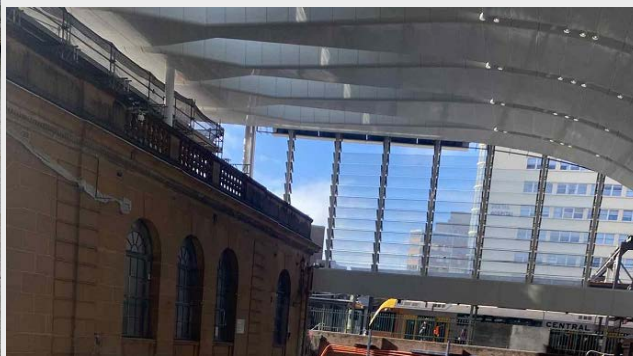

G17 Electrical Engineering Building Capital Renewal, UNSW

Scope: Supply bespoke Sloped Alu
6061-T6, Interpon Precis Dark Bronze

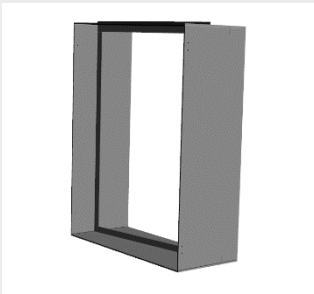

Neville Bonner Pedestrian Bridge QLD

Scope: 3500sqm 5052-

H32 4mm Alu panels & 6061 RHS packages

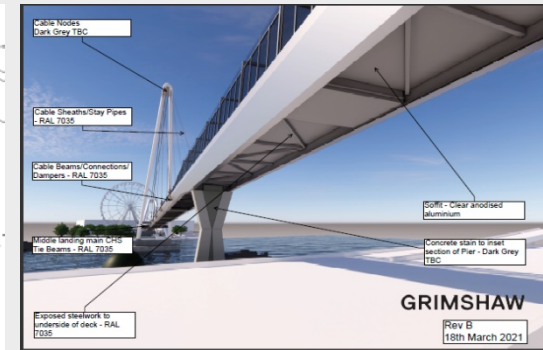
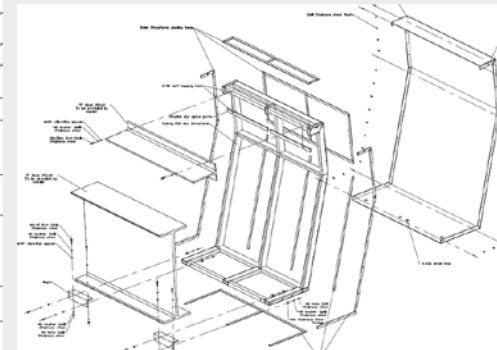
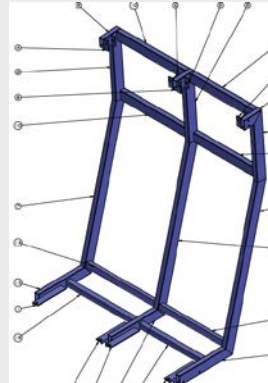
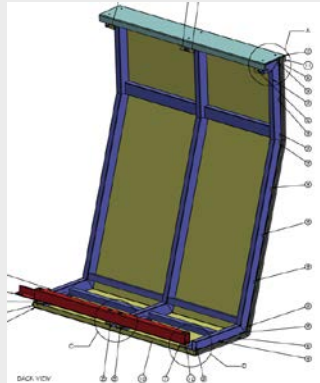
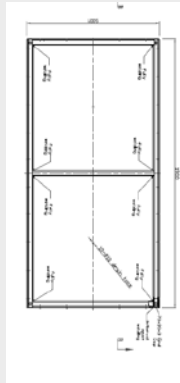

Melbourne Metro Line

Scope: Stainless steel
pacakges&alu ceiling pacakges

